

NATURAL SCIENCES  
ADMISSIONS ASSESSMENT

D568/31

November 2020

60 minutes

## SECTION 1

## INSTRUCTIONS TO CANDIDATES

Please read these instructions carefully, but do not open this question paper until you are told that you may do so. This paper is Section 1 of 2.

A separate answer sheet is provided for this paper. Please check you have one. You also require a soft pencil and an eraser.

Please complete the answer sheet with your candidate number, centre number, date of birth, and name.

At the end of 60 minutes, your supervisor will collect this question paper and answer sheet before giving out Section 2.

This paper contains **four** parts: **A**, **B**, **C** and **D**.

All candidates should complete **Part A** Mathematics.

All candidates should then complete **one** further part chosen from:

<b>Part B</b>	Physics
<b>Part C</b>	Chemistry
<b>Part D</b>	Biology

Each part has 20 multiple-choice questions. There are no penalties for incorrect responses, only marks for correct answers, so you should attempt all of the questions in your **two** parts. Each question is worth one mark.

For each question, choose the **one** option you consider correct and record your choice on the separate answer sheet. If you make a mistake, erase thoroughly and try again.

You **must** complete the answer sheet within the time limit.

You can use the question paper for rough working, but **no extra paper** is allowed. Only your responses on the answer sheet will be marked.

Dictionaries and calculators are NOT permitted.

**Please wait to be told you may begin before turning this page.**

*This question paper consists of 69 printed pages and 7 blank pages.*



**BLANK PAGE**

**Paper content**

PART A Mathematics .....	5
PART B Physics .....	19
PART C Chemistry .....	37
PART D Biology .....	53

**BLANK PAGE**

**PART A Mathematics**

- 1 The admission charge to a cinema is different for adults and children.

Admission for 2 adults and 3 children costs £20.

Admission for 4 adults and 4 children costs £34.

What does admission cost for 6 adults and 2 children?

- A £27
- B £29
- C £33
- D £39
- E £44
- F £48
- G £72

- 2 The  $n^{\text{th}}$  term of a sequence is  $2n - 5$ .

Which row in the table is correct for this sequence?

	<i>term-to-term rule</i>	<i>term which has a value of 17</i>
<b>A</b>	subtract 5	11 <sup>th</sup>
<b>B</b>	subtract 5	29 <sup>th</sup>
<b>C</b>	subtract 2	11 <sup>th</sup>
<b>D</b>	subtract 2	29 <sup>th</sup>
<b>E</b>	add 5	11 <sup>th</sup>
<b>F</b>	add 5	29 <sup>th</sup>
<b>G</b>	add 2	11 <sup>th</sup>
<b>H</b>	add 2	29 <sup>th</sup>

- 3 A fair spinner has eight equal sections.

Each section has one number written on it, as shown.

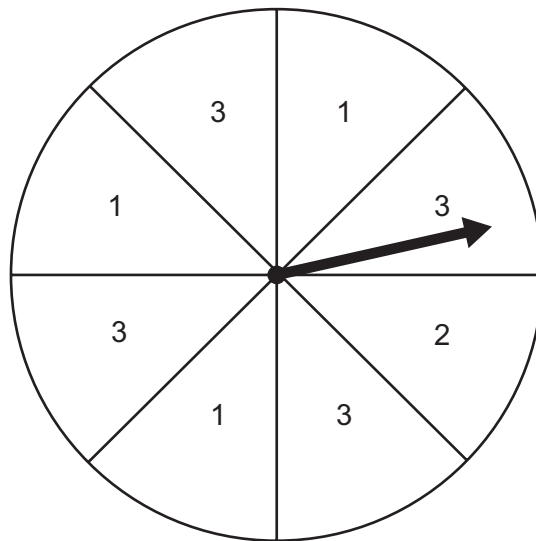

The spinner is spun twice, and the two numbers scored are added.

What is the probability that the sum of the two numbers is 5?

- A  $\frac{1}{8}$   
B  $\frac{5}{8}$   
C  $\frac{1}{16}$   
D  $\frac{3}{16}$   
E  $\frac{25}{64}$   
F  $\frac{55}{64}$

4

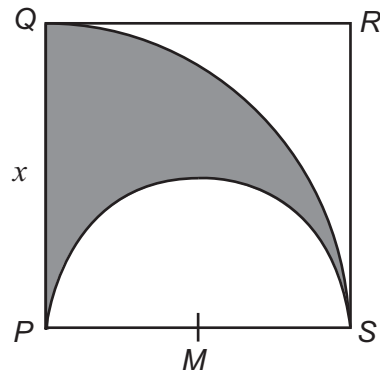

$PQRS$  is a square with side length  $x$ .

$M$  is the midpoint of side  $PS$ .

A circular arc, with centre  $M$ , is drawn inside the square from  $S$  to  $P$ .

Another circular arc, with centre  $P$ , is drawn inside the square from  $S$  to  $Q$ .

What is the area of the shaded region in terms of  $x$ ?

- A**  $\frac{1}{8}\pi x^2$
- B**  $\frac{3}{16}\pi x^2$
- C**  $\frac{1}{4}\pi x^2$
- D**  $\frac{5}{16}\pi x^2$
- E**  $\frac{3}{8}\pi x^2$
- F**  $\frac{7}{16}\pi x^2$
- G**  $\frac{1}{2}\pi x^2$



- 5 A balloon contains  $5000\text{cm}^3$  of gas.

The gas in the balloon gradually escapes so that the volume of the balloon decreases.

60% of the volume of the balloon is lost each week.

What is the volume of the balloon, in  $\text{cm}^3$ , after 3 weeks?

- A 0
- B 128
- C 320
- D 800
- E 1080

- 6 Consider the four lines with the following equations.

1  $2x + 6y = 3$

2  $9y = 3x - 4$

3  $2y = 6x + 3$

4  $4x + 6y - 9 = 0$

Which two lines are perpendicular?

- A 1 and 2
- B 1 and 3
- C 1 and 4
- D 2 and 3
- E 2 and 4
- F 3 and 4

7 The equilateral triangle  $PQR$  has sides of length 8 cm.

A circle, centre  $O$ , passes through each of the vertices of the triangle.

Find an expression for the circumference of the circle, in cm.

A  $\frac{\sin 60^\circ}{8\pi}$

B  $\frac{8\pi}{\sin 60^\circ}$

C  $\frac{\cos 60^\circ}{8\pi}$

D  $\frac{8\pi}{\cos 60^\circ}$

E  $\frac{\tan 60^\circ}{8\pi}$

F  $\frac{8\pi}{\tan 60^\circ}$

8 Find the sum of the solutions of

$$2\left(\frac{x}{4}+3\right)^2 - \left(\frac{x}{4}+3\right) - 36 = 0$$

A 2

B  $\frac{3}{2}$

C  $\frac{1}{2}$

D -4

E -13

F -22

G -26

H -34

- 9 When the expression

$$(2x + 3)^2 - (x - 3)^2$$

is written in the form  $p(x + q)^2 + r$ , where  $p$ ,  $q$  and  $r$  are constants, what is the value of  $r$ ?

- A -27
- B -9
- C 0
- D 3
- E 15

- 10 Which one of the following expressions is equivalent to

$$\frac{a}{b/c} - \frac{a/b}{c}$$

- A 0
- B  $\frac{a(b^2 - 1)}{bc}$
- C  $\frac{a(b^2 - c^2)}{bc}$
- D  $\frac{a^2b^2 - c^2}{abc}$
- E  $\frac{a(c^2 - 1)}{bc}$
- F  $\frac{a^2c^2 - b^2}{abc}$
- G  $\frac{b^2 - a^2}{abc}$

- 11 The table shows statistics relating to the test marks of two groups of students.

	<i>number of students</i>	<i>mean</i>	<i>range</i>
<i>group X</i>	10	36	16
<i>group Y</i>	20	48	21

The results for the two groups of students are combined.

What can be deduced about the mean and range of the combined results?

- A mean = 40, range  $\leq 16$
- B mean = 40,  $16 < \text{range} < 21$
- C mean = 40, range  $\geq 21$
- D mean = 44, range  $\leq 16$
- E mean = 44,  $16 < \text{range} < 21$
- F mean = 44, range  $\geq 21$
- 12 The number of pairs of winter boots sold on a day is inversely proportional to the cube of the outside temperature on that day, measured in  $^{\circ}\text{C}$ .

On a day when the outside temperature is  $8^{\circ}\text{C}$ , 250 pairs of boots are sold.

The next day, when the outside temperature is  $x^{\circ}\text{C}$ , the number of pairs of boots sold is 700% more than on the previous day.

What is the value of  $x$ ?

- A 2
- B 4
- C  $\frac{8}{\sqrt[3]{7}}$
- D  $8\sqrt[3]{7}$
- E 16

- 13** In a sale, all prices are reduced by 25%.

A customer calculates the pre-sale price of a bicycle incorrectly by increasing the marked sale price by 25%.

The customer's calculated pre-sale price is incorrect by £15.

What is the correct pre-sale price of the bicycle?

- A** £180
- B** £195
- C** £210
- D** £225
- E** £240

- 14** A paint colour is a mixture of red paint, blue paint and yellow paint.

The ratio of red paint to blue paint in the mixture is 18 : 5

The ratio of blue paint to yellow paint in the mixture is  $p : 3$

The ratio of red paint to yellow paint in the mixture is 12 : 5

What is the value of  $p$ ?

- A** 2
- B** 4.5
- C** 5
- D** 7.5
- E** 12

15

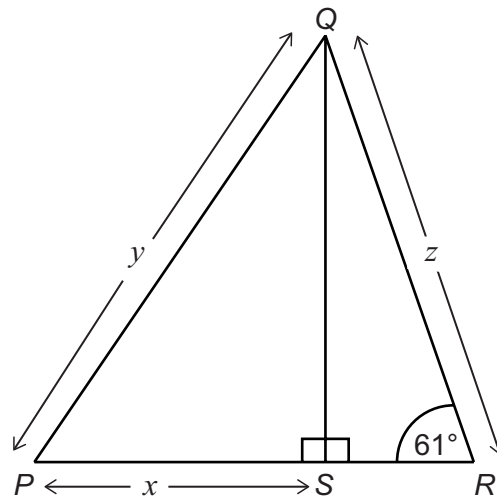

[diagram not to scale]

In the diagram,  $QS$  is perpendicular to  $PR$ .

$$PS = x \text{ cm}$$

$$PQ = y \text{ cm}$$

$$QR = z \text{ cm}$$

$$\text{angle } QRS = 61^\circ$$

$PSR$  is a straight line.

Which one of the following is an expression for the length  $z$ , in cm?

**A**  $\sqrt{y^2 + x^2} \sin 61^\circ$

**B**  $\sqrt{y^2 - x^2} \sin 61^\circ$

**C**  $\sqrt{y^2 + x^2} \cos 61^\circ$

**D**  $\sqrt{y^2 - x^2} \cos 61^\circ$

**E**  $\frac{\sqrt{y^2 + x^2}}{\sin 61^\circ}$

**F**  $\frac{\sqrt{y^2 - x^2}}{\sin 61^\circ}$

**G**  $\frac{\sqrt{y^2 + x^2}}{\cos 61^\circ}$

**H**  $\frac{\sqrt{y^2 - x^2}}{\cos 61^\circ}$

- 16** Two identical fair six-sided dice each have their faces numbered from 1 to 6, with one number on each face.

Both dice are thrown, and the number on each of the dice is recorded.

They are then both thrown again, and the number on each of the dice is recorded.

What is the probability that at least one of the four recorded numbers is even?

- A**  $\frac{1}{4}$
- B**  $\frac{1}{2}$
- C**  $\frac{9}{16}$
- D**  $\frac{3}{4}$
- E**  $\frac{15}{16}$

- 17** The quadratic equation  $2x^2 - px - 4 = 0$ , where  $p$  is a positive constant, has two solutions that differ by 6.

What is the value of  $p$ ?

- A** 2
- B**  $4\sqrt{7}$
- C** 12
- D**  $4\sqrt{11}$
- E**  $4\sqrt{34}$
- F**  $6\sqrt{30}$

- 18 Two vertices of a square are at  $(1, 1)$  and  $(3, 5)$ .

What is the difference between the perimeters of the largest and smallest possible squares that can be drawn with these points as two of their vertices?

A 0

B  $4\sqrt{3}(2 - \sqrt{2})$

C  $4\sqrt{3}(\sqrt{2} - 1)$

D  $4\sqrt{5}(2 - \sqrt{2})$

E  $4\sqrt{5}(\sqrt{2} - 1)$

F  $4\sqrt{13}(2 - \sqrt{2})$

G  $4\sqrt{13}(\sqrt{2} - 1)$

H  $4\sqrt{3}\sqrt{5}(2 - \sqrt{2})$



- 19 The point  $M$  is  $(2, 5)$  and the point  $N$  is  $(-3, -1)$ .

The line segment  $MN$  is transformed to the line segment  $TU$  by two transformations:

$MN$  is rotated  $90^\circ$  clockwise about the origin to give the line segment  $RS$ .

$RS$  is then translated by the vector  $\begin{pmatrix} p \\ q \end{pmatrix}$  to give the line segment  $TU$ .

The coordinates of the midpoint of  $TU$  are  $(7, -2.5)$ .

Find the vector  $\begin{pmatrix} p \\ q \end{pmatrix}$

A  $\begin{pmatrix} 2 \\ 0.5 \end{pmatrix}$

B  $\begin{pmatrix} 0.5 \\ 2 \end{pmatrix}$

C  $\begin{pmatrix} 5 \\ -3 \end{pmatrix}$

D  $\begin{pmatrix} -3 \\ 5 \end{pmatrix}$

E  $\begin{pmatrix} 9 \\ -2 \end{pmatrix}$

F  $\begin{pmatrix} -2 \\ 9 \end{pmatrix}$

- 20** A solid cone has a base radius  $x$  cm.

The ratio of the perpendicular height of the cone to the radius of the cone is 5 : 2

A solid hemisphere of radius  $\frac{y}{2}$  cm is made from the same material as the cone.

Which one of the following is a correct expression for

$$\frac{\text{volume of the cone}}{\text{volume of the hemisphere}}$$

(Volume of a cone =  $\frac{1}{3}\pi r^2 h$  where  $r$  is the radius and  $h$  is the perpendicular height.)

(Volume of a sphere =  $\frac{4}{3}\pi r^3$  where  $r$  is the radius.)

- A**  $\frac{5x^3}{y^3}$
- B**  $\frac{5x^3}{4y^3}$
- C**  $\frac{8x^3}{5y^3}$
- D**  $\frac{10x^3}{y^3}$
- E**  $\frac{14x^3}{y^3}$

**PART B Physics**

- 21 The diagram represents the structure of a charged atom (ion) of one isotope of an element.

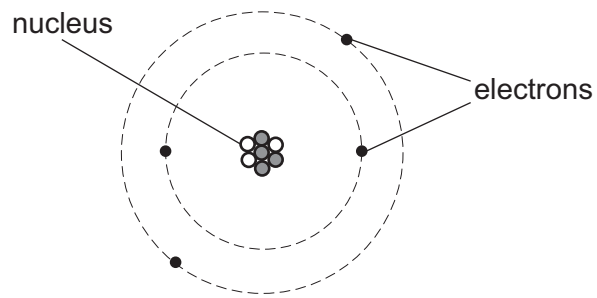

Which diagram represents the structure of an oppositely charged ion of a different isotope of the same element?

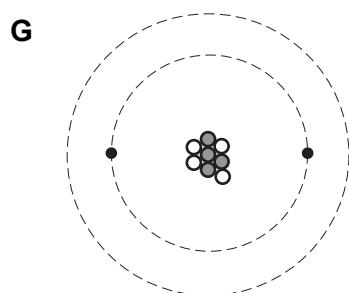
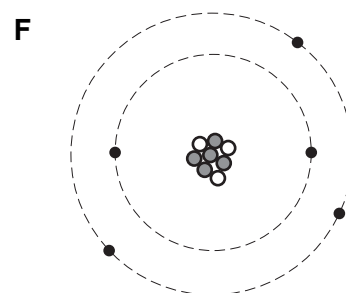
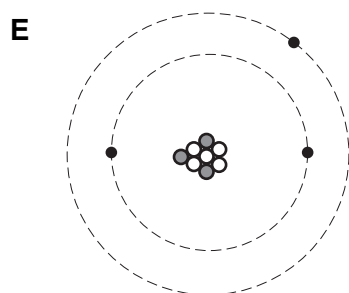
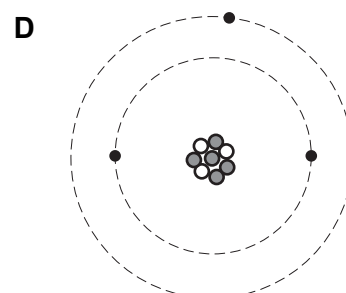
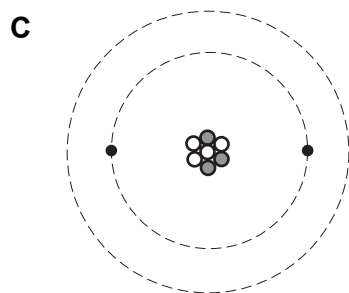
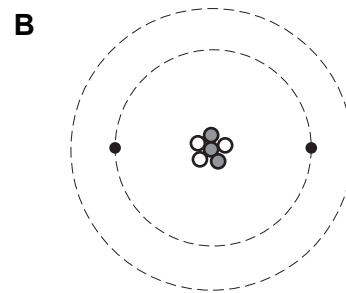
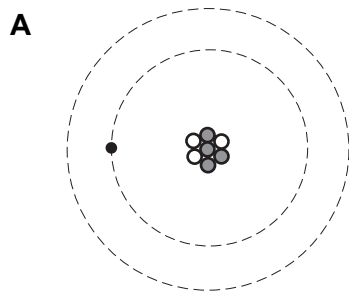

**22** A soldering iron has a copper tip of mass 2.0 g.

The tip is heated with 30 W of thermal power. In 50 s, the temperature of the tip increases by 200 °C.

How much energy is transferred from the tip to the surroundings in this time?

(specific heat capacity of copper =  $400 \text{ J kg}^{-1} \text{ }^\circ\text{C}^{-1}$ )

- A** 160 J
- B** 500 J
- C** 1340 J
- D** 1500 J
- E** 1660 J
- F** 1840 J
- G** 2500 J

- 23 A water wave is travelling in a shallow tank of water. The wave passes from region X into region Y where the speed of the wave differs from that in region X. The diagram shows the directions of travel in the two regions and peaks of the wave that are separated by one wavelength.

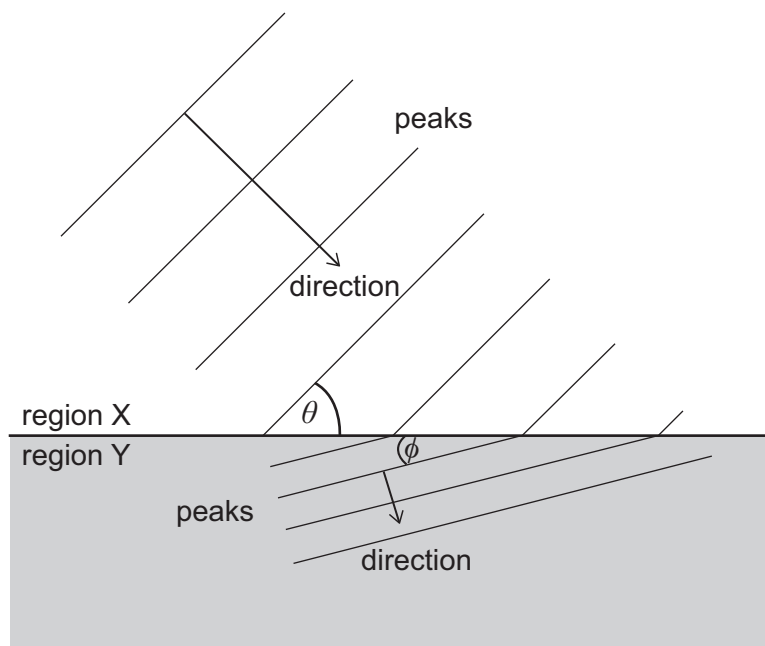

In region X, the angle between the wave peaks and the boundary between the regions is  $\theta$ .

In region Y, the angle between the wave peaks and the boundary is  $\phi$ .

What are the angle of incidence and the angle of refraction, and in which region is the speed of the wave greater?

	<i>angle of incidence</i>	<i>angle of refraction</i>	<i>speed greater in region</i>
<b>A</b>	$\theta$	$\phi$	X
<b>B</b>	$\theta$	$\phi$	Y
<b>C</b>	$\theta$	$90^\circ - \phi$	X
<b>D</b>	$\theta$	$90^\circ - \phi$	Y
<b>E</b>	$90^\circ - \theta$	$\phi$	X
<b>F</b>	$90^\circ - \theta$	$\phi$	Y
<b>G</b>	$90^\circ - \theta$	$90^\circ - \phi$	X
<b>H</b>	$90^\circ - \theta$	$90^\circ - \phi$	Y

- 24 A sample of an ideal gas is sealed in a cylindrical container by a piston as shown in the diagram.

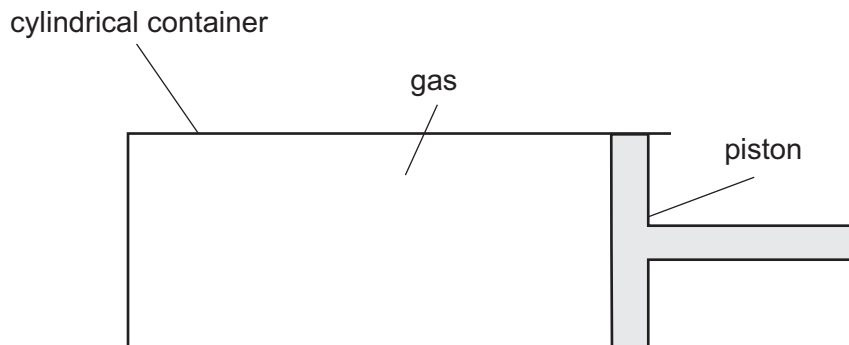

The particles of the gas are moving with an average speed  $v$ , and collide with the surface of the piston with a frequency  $f$ .

The piston is now slowly pushed into the cylinder until the gas occupies half of its original volume, but the gas remains at the same temperature.

What is the new average speed of the particles of the gas, and at what frequency do they now collide with the surface of the piston?

	<i>average speed</i>	<i>frequency</i>
<b>A</b>	$2v$	$\frac{1}{2}f$
<b>B</b>	$2v$	$f$
<b>C</b>	$2v$	$2f$
<b>D</b>	$v$	$\frac{1}{2}f$
<b>E</b>	$v$	$f$
<b>F</b>	$v$	$2f$

- 25 In a laboratory, liquid nitrogen is stored at a very low temperature in the vessel shown in the diagram.

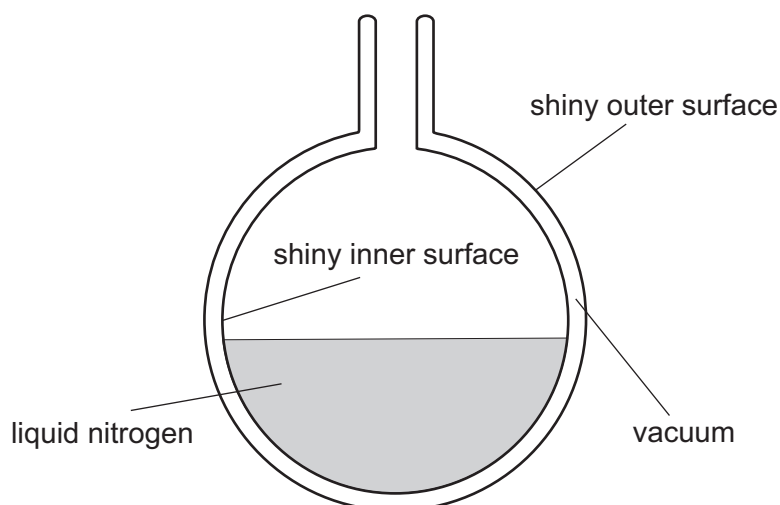

The vessel has a double wall made from a poor thermal conductor. There is a vacuum in the gap between the two walls.

The inner surface of the inner wall is shiny. The outer surface of the outer wall is shiny.

These features insulate the liquid nitrogen by reducing the rate at which thermal energy is transferred to the liquid nitrogen.

Which of the following statements explain(s) why these features help to insulate the liquid nitrogen?

- 1 The shiny inner surface of the inner wall is a good emitter of thermal radiation.
  - 2 Thermal radiation cannot travel in a vacuum.
  - 3 The shiny outer surface of the outer wall is a poor absorber of radiation.
- A** none of them
- B** 1 only
- C** 2 only
- D** 3 only
- E** 1 and 2 only
- F** 1 and 3 only
- G** 2 and 3 only
- H** 1, 2 and 3



- 26 Uranium-238 ( ${}^{238}_{92}\text{U}$ ) decays by a series of alpha and beta ( $\beta^-$ ) emissions to become the stable isotope lead-206 ( ${}^{206}_{82}\text{Pb}$ ).

How many beta ( $\beta^-$ ) particles are emitted in the decay of one uranium-238 nucleus to lead-206?

- A 6
- B 8
- C 10
- D 12
- E 14
- F 16

- 27 A dc electricity transmission system uses an undersea cable to send electricity from one country to another. On a particular day, the first country supplies electricity at a voltage of 400 kV and 2000 A to the transmission system. The second country receives electricity from the transmission system at 160 kV and 4000 A.

What is the percentage efficiency of the system and how much energy is wasted every minute?

	<i>efficiency %</i>	<i>energy wasted every minute / J</i>
<b>A</b>	20	$9.6 \times 10^9$
<b>B</b>	20	$3.84 \times 10^{10}$
<b>C</b>	20	$4.8 \times 10^{10}$
<b>D</b>	80	$9.6 \times 10^9$
<b>E</b>	80	$3.84 \times 10^{10}$
<b>F</b>	80	$4.8 \times 10^{10}$

28 The primary coil of an ideal, 100% efficient transformer is connected to a 240 V mains supply.

A lamp L that is connected to the secondary coil has a voltage of 12 V across it. An identical lamp and a switch S are also connected to the transformer as shown in the diagram.

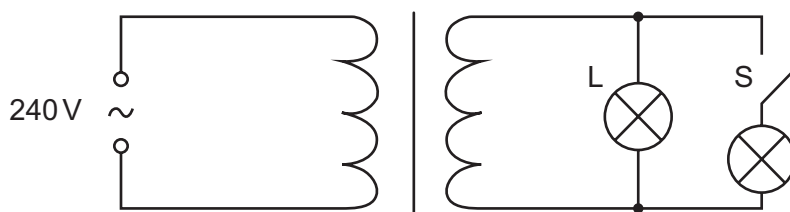

With the switch open, the current in the primary coil is 0.10 A.

The switch is now closed.

What is the current in the primary coil now and what is the current in lamp L?

	<i>current in primary coil / A</i>	<i>current in lamp L / A</i>
<b>A</b>	0.10	1.0
<b>B</b>	0.10	2.0
<b>C</b>	0.10	4.0
<b>D</b>	0.20	1.0
<b>E</b>	0.20	2.0
<b>F</b>	0.20	4.0

- 29 Two fixed horizontal metal rails are side by side and 12 cm apart. The rails are connected to a dc power supply by a switch that is initially open.

A freely moveable metal rod of length 20 cm is placed on the rails as shown in the diagram. The diagram shows the arrangement seen from above.

The angle between the rod and the rails is  $90^\circ$ .

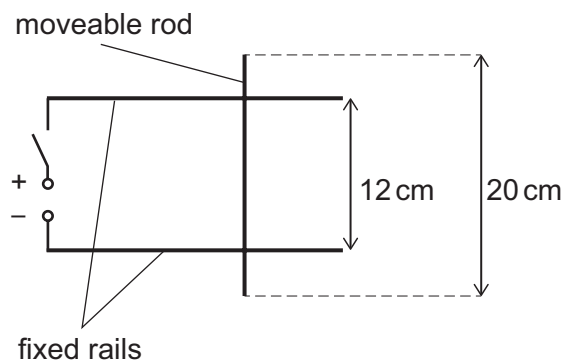

The whole arrangement is placed in a uniform magnetic field of magnitude 0.50 T that is directed perpendicularly into the page.

The moveable rod has a weight of 0.40 N.

The switch is now closed. As a result, there is a current of 2.4 A in the circuit and the rod moves.

What is the initial magnitude of the acceleration of the rod and what is its direction?

(gravitational field strength =  $10 \text{ N kg}^{-1}$ )

	<i>acceleration / m s<sup>-2</sup></i>	<i>direction</i>
<b>A</b>	0.36	to the left
<b>B</b>	0.36	to the right
<b>C</b>	0.60	to the left
<b>D</b>	0.60	to the right
<b>E</b>	3.6	to the left
<b>F</b>	3.6	to the right
<b>G</b>	6.0	to the left
<b>H</b>	6.0	to the right

- 30 A circuit contains a 12 V battery, a thermistor and a fixed resistor connected in series. The graph shows how the resistance of the thermistor varies with temperature.

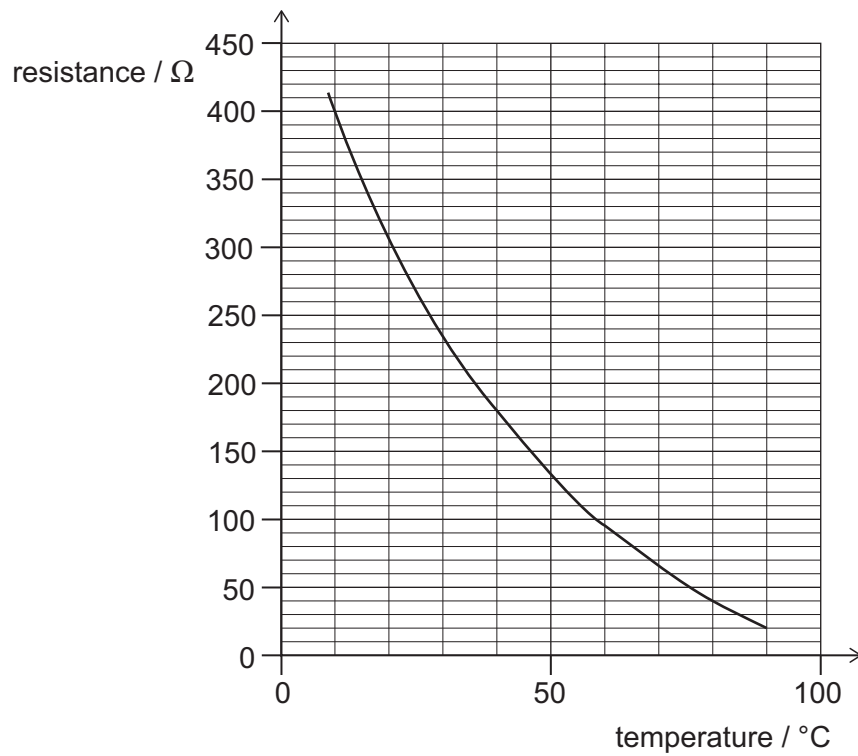

When the temperature of the thermistor is  $10^{\circ}\text{C}$  the current in the circuit is 25 mA.

What is the current when the temperature of the thermistor is  $80^{\circ}\text{C}$ ?

- A 30 mA
- B 80 mA
- C 100 mA
- D 120 mA
- E 150 mA
- F 300 mA
- G 480 mA

- 31** Two trolleys are moving towards each other along a straight horizontal track.  
One trolley has mass 8.0 kg and is travelling to the right at  $4.0 \text{ m s}^{-1}$ .  
The other trolley has mass 2.0 kg and is travelling to the left at  $1.0 \text{ m s}^{-1}$ .  
When the trolleys collide they stick together.  
How much kinetic energy is transferred to other forms of energy in the collision?
- A** 2.0 J
  - B** 18 J
  - C** 20 J
  - D** 28 J
  - E** 35 J
  - F** 40 J
  - G** 45 J
  - H** 65 J
- 32** Visible light waves are electromagnetic waves that travel through a vacuum at  $300\,000 \text{ km s}^{-1}$  with wavelengths that range from 400 nm to 750 nm.  
The electromagnetic waves emitted by a source are all at frequencies between  $6.0 \times 10^{12} \text{ Hz}$  and  $6.0 \times 10^{14} \text{ Hz}$ .  
Which statement about the waves emitted by the source is correct?
- A** Infrared waves are emitted, but not ultraviolet or visible light waves.
  - B** Infrared and visible light waves are emitted, but not ultraviolet waves.
  - C** Infrared, ultraviolet and visible light waves are all emitted.
  - D** Ultraviolet waves are emitted, but not infrared or visible light waves.
  - E** Ultraviolet and visible light waves are emitted, but not infrared waves.

- 33** Cubes of side 2.0 cm are tightly packed into a rectangular box with internal dimensions 12.0 cm × 10.0 cm × 6.0 cm.

Each cube is either solid concrete or solid steel. There are twice as many steel cubes as concrete cubes.

What is the total mass of the cubes in the box?

(density of concrete = 2.0 g cm<sup>-3</sup>; density of steel = 8.0 g cm<sup>-3</sup>)

- A 2880 g
- B 3240 g
- C 3600 g
- D 3840 g
- E 4320 g
- F 4800 g

- 34 A car of mass 800 kg travels in a straight line along a horizontal road.

The car accelerates **non-uniformly** from rest for 5.0 seconds and then moves at constant speed, as shown in the distance–time graph:

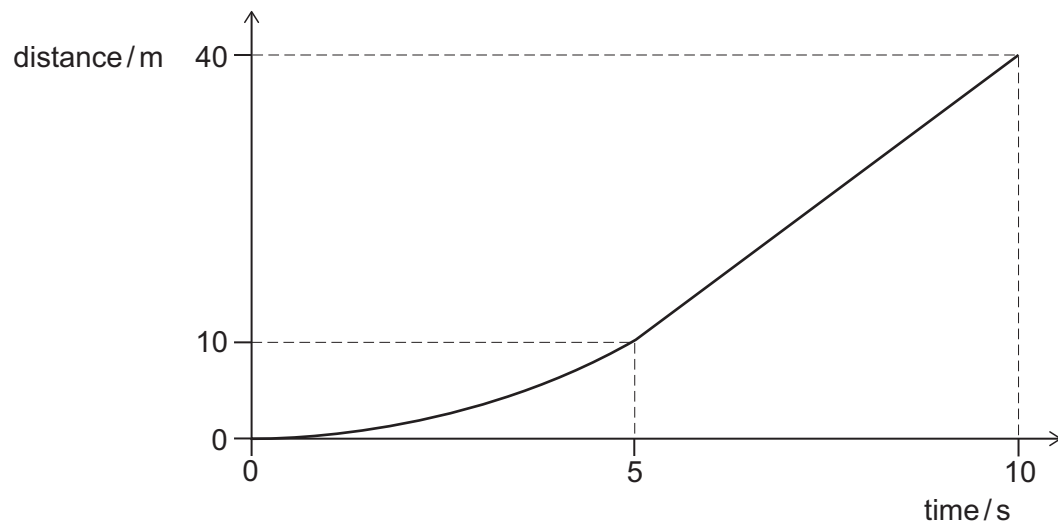

What is the average resultant force acting on the car over the time for which it is accelerating?

- A 320 N
- B 480 N
- C 640 N
- D 960 N
- E 1600 N
- F 3200 N
- G 4800 N

- 35** A sample contains only one radioactive isotope. This isotope decays in a single step with a half-life of 120 minutes to a stable isotope.

The sample is placed near to a radiation detector which measures the count rate. The count rate reading is 910 counts per minute (cpm).

After 240 minutes the measurement is repeated. The count rate reading is now 238 cpm.

After a further 360 minutes have elapsed, a third measurement of the count rate is made.

What is the count rate due to background radiation and what is the expected reading in the third measurement?

	<i>background count rate / cpm</i>	<i>third measurement / cpm</i>
<b>A</b>	224	148
<b>B</b>	224	226
<b>C</b>	142	28
<b>D</b>	142	148
<b>E</b>	142	154
<b>F</b>	14	14
<b>G</b>	14	28
<b>H</b>	14	42

- 36** P and Q are two fixed points on the surface of the ocean which are 6.0m apart.

An ocean wave travels in the direction P to Q.

The wave has a frequency of 0.50Hz and travels at a constant speed.

A wave peak passes Q at time  $t = 0$  s.

The next wave peak travelling towards Q passes P at time  $t = 0.80$  s.

What is the speed of the wave?

- A**  $2.1 \text{ ms}^{-1}$
- B**  $3.4 \text{ ms}^{-1}$
- C**  $5.0 \text{ ms}^{-1}$
- D**  $7.5 \text{ ms}^{-1}$
- E**  $20 \text{ ms}^{-1}$



- 37** A parachutist of mass  $80.0\text{ kg}$  drops from a plane travelling at  $40.0\text{ m s}^{-1}$ ,  $2000\text{ m}$  above the Earth's surface.

The parachutist hits the ground at a speed of  $5.00\text{ m s}^{-1}$ .

How much work is done by the parachutist against drag forces during the fall?

(Take the Earth's gravitational field strength to be  $10.0\text{ N kg}^{-1}$ .)

- A**  $1\,535\,000\text{ J}$
- B**  $1\,624\,000\text{ J}$
- C**  $1\,649\,000\text{ J}$
- D**  $1\,663\,000\text{ J}$
- E**  $1\,726\,000\text{ J}$

- 38** A solid uniform sphere is made of metal of density  $\rho_S$  and has radius  $r$  and volume  $V$ . It falls vertically through a viscous liquid of density  $\rho_L$ .

Three forces act on it: its weight, a drag force  $D$  and an upthrust  $U$ . The magnitude of the upthrust force is equal to the weight of the liquid displaced by the sphere.

The magnitude of the drag force is given by:

$$D = krv$$

where  $v$  is the speed of the metal sphere and  $k$  is a constant.

What is the terminal speed of the metal sphere as it falls through this liquid?

(gravitational field strength =  $g$ )

- A**  $\frac{\rho_L g}{Vrk}$
- B**  $\frac{\rho_S g}{Vrk}$
- C**  $\frac{g(\rho_S - \rho_L)}{Vrk}$
- D**  $\frac{g(\rho_S + \rho_L)}{Vrk}$
- E**  $\frac{V\rho_L g}{rk}$
- F**  $\frac{V\rho_S g}{rk}$
- G**  $\frac{Vg(\rho_S - \rho_L)}{rk}$
- H**  $\frac{Vg(\rho_S + \rho_L)}{rk}$

- 39** A rocket travelling in space is burning its fuel at a constant rate. By expelling the burnt fuel through a nozzle, the engine is applying a constant force to the rocket.

What is happening to the magnitude of the acceleration of the rocket?

- A** It is increasing at an increasing rate.
  - B** It is increasing at a constant rate.
  - C** It is increasing at a decreasing rate.
  - D** It is not changing.
  - E** It is decreasing at an increasing rate.
  - F** It is decreasing at a constant rate.
  - G** It is decreasing at a decreasing rate.
- 40** A light spring of unstretched length 0.10 m has a spring constant of  $20 \text{ N m}^{-1}$ . The spring is suspended so that it is vertical and a load of mass 0.050 kg is attached to the end of the spring.

The load is pulled vertically downwards until the length of the spring is 0.30 m. The load is then released.

What is the speed of the load at the instant that the spring returns to its unstretched length?

(gravitational field strength =  $10 \text{ N kg}^{-1}$ ; assume that resistive forces are negligible)

- A**  $0 \text{ ms}^{-1}$
- B**  $4.0 \text{ ms}^{-1}$
- C**  $6.0 \text{ ms}^{-1}$
- D**  $12 \text{ ms}^{-1}$
- E**  $16 \text{ ms}^{-1}$
- F**  $\sqrt{6} \text{ ms}^{-1}$
- G**  $\sqrt{12} \text{ ms}^{-1}$
- H**  $\sqrt{30} \text{ ms}^{-1}$

**BLANK PAGE**

**PART C Chemistry**

41 Use the following data table to answer the question.

<i>gas</i>	<i>melting point / °C</i>	<i>boiling point / °C</i>
hydrogen	-259	-253
nitrogen	-210	-196
oxygen	-219	-183
neon	-249	-246
argon	-189	-186

Water and carbon dioxide were removed from a sample of air and the remaining mixture was cooled to  $-260^{\circ}\text{C}$ .

The three most abundant remaining elements are to be separated by fractional distillation.

In which order would these three elements be collected?

- A hydrogen, neon, nitrogen
- B hydrogen, neon, oxygen
- C neon, nitrogen, argon
- D neon, nitrogen, oxygen
- E nitrogen, argon, oxygen
- F nitrogen, oxygen, argon
- G oxygen, nitrogen, argon
- H oxygen, argon, nitrogen

- 42** Consider **only** the first three metals in Group 1 (Li, Na, K) and **only** the first three elements in Group 17 (F, Cl, Br).

Which of the following statements is/are correct for the compound lithium bromide?

- 1** It is formed from the least reactive of the three Group 17 elements.
  - 2** It is formed from the least reactive of the three Group 1 elements and the Group 17 element (of the three) with the lowest boiling point.
  - 3** It is formed from the Group 1 element (of the three) with the highest melting point.
- A** none of them
- B** 1 only
- C** 2 only
- D** 3 only
- E** 1 and 2 only
- F** 1 and 3 only
- G** 2 and 3 only
- H** 1, 2 and 3

43 Which of the following tests could be used, on its own, to distinguish between all three of the following white solids: potassium carbonate, calcium chloride and sodium sulfate?

- 1 Add a small amount of each solid separately to a platinum wire and hold in a colourless flame.
- 2 Dissolve a small amount of each solid separately in deionised water and add a few drops of sodium hydroxide solution.
- 3 Dissolve a small amount of each solid separately in deionised water and add a few drops of hydrochloric acid, followed by barium chloride solution.

A none of them

B 1 only

C 2 only

D 3 only

E 1 and 2 only

F 1 and 3 only

G 2 and 3 only

H 1, 2 and 3

44 Molecule J is a straight-chain hydrocarbon containing one carbon-carbon double bond.

The relative atomic mass ( $A_r$ ) of hydrogen is 1 and carbon is 12.

What is the **minimum** additional information that is needed in order to determine the molecular formula of molecule J?

- 1 The percentage by mass of carbon in the molecule.
- 2 The percentage by mass of hydrogen in the molecule.
- 3 The relative molar mass ( $M_r$ ) of the molecule.

A 1 only

B 3 only

C 1 and 2 only

D 1 and 3 only

E 1, 2 and 3



- 45 Iodic acid,  $\text{HIO}_3$ , can be made from iodine in the following reaction:

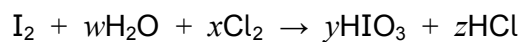

What is the value of  $x$  when the equation is balanced?

- A 1
  - B 2
  - C 3
  - D 4
  - E 5
  - F 6
- 46 Which one of the following formulae is correct for the compound given?
- A aluminium sulfate,  $\text{Al}(\text{SO}_4)_3$
  - B ammonium carbonate,  $(\text{NH}_4)_2\text{CO}_3$
  - C calcium hydroxide,  $\text{CaOH}$
  - D magnesium nitrate,  $\text{MgNO}_3$
  - E potassium bromide,  $\text{KBr}_2$

- 47 Which of the following statements about elements in the Periodic Table is/are correct?
- 1 When the element in Period 5, Group 2 reacts with the element that is in Period 3, Group 17, a redox reaction occurs.
  - 2 In each Group, the elements from Period 2 are more reactive than the elements from Period 5.
  - 3 The compound formed between the element in Period 2, Group 14 and the element in Period 3, Group 17 will have a simple molecular structure.
- A none of them
- B 1 only
- C 2 only
- D 3 only
- E 1 and 2 only
- F 1 and 3 only
- G 2 and 3 only
- H 1, 2 and 3

48 Some dilute aqueous solutions were electrolysed using graphite electrodes.

Which of the rows in the table show(s) the correct products of electrolysis?

	<i>aqueous electrolyte</i>	<i>products of electrolysis</i>	
		<i>at the cathode (negative electrode)</i>	<i>at the anode (positive electrode)</i>
<b>1</b>	potassium hydroxide	potassium	oxygen
<b>2</b>	copper(II) chloride	chlorine	copper
<b>3</b>	sodium sulfate	hydrogen	sulfur

- A none of them
- B 1 only
- C 2 only
- D 3 only
- E 1 and 2 only
- F 1 and 3 only
- G 2 and 3 only
- H 1, 2 and 3

49 A paper chromatogram is set up with an orange food colouring spotted on the baseline.

Ten minutes after the start, the solvent front has moved 15.0 cm up the paper from the baseline and a yellow spot is 12.0 cm above the baseline.

Five minutes later, the solvent front has moved up a further 10.0 cm.

How far from the baseline will the yellow spot be 15 minutes after the start?

- A 8.0 cm
- B 12.0 cm
- C 15.0 cm
- D 20.0 cm
- E 22.0 cm
- F 25.0 cm
- G 31.3 cm

50 Which of the following equations represent(s) a redox reaction?

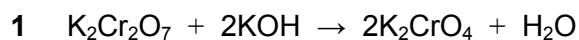

A none of them

B 1 only

C 2 only

D 3 only

E 1 and 2 only

F 1 and 3 only

G 2 and 3 only

H 1, 2 and 3

51  $100\text{ cm}^3$  of ethane is mixed with  $1400\text{ cm}^3$  of oxygen and the mixture is ignited.

All volumes are measured at atmospheric pressure and a temperature of  $150^\circ\text{C}$ .

What will be the **total** volume of gas after the complete combustion?

(Assume that equal amounts of any gas at the same temperature and pressure occupy the same volume.)

A  $500\text{ cm}^3$

B  $1250\text{ cm}^3$

C  $1500\text{ cm}^3$

D  $1550\text{ cm}^3$

E  $1700\text{ cm}^3$

F  $2000\text{ cm}^3$

- 52** 10 g of a mixture of solid magnesium hydroxide,  $\text{Mg}(\text{OH})_2$ , and solid sodium hydroxide,  $\text{NaOH}$ , is added to an excess of water and stirred.

One of the components of the mixture dissolves. Assume that the other is completely insoluble.

The mixture is filtered to remove the insoluble component of the mixture.

$50 \text{ cm}^3$  of  $1.0 \text{ mol dm}^{-3}$  sulfuric acid exactly neutralises the remaining solution.

What is the mass of magnesium hydroxide in the original mixture?

( $M_r$  values:  $\text{Mg}(\text{OH})_2 = 58$ ;  $\text{NaOH} = 40$ )

- A** 2.0 g
- B** 2.9 g
- C** 4.0 g
- D** 5.8 g
- E** 6.0 g
- F** 8.0 g

- 53 Calcium carbonate reacts with hydrochloric acid according to the following chemical equation:

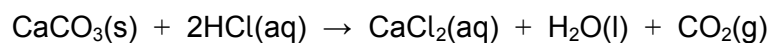

Line **P** on the graph shows how the volume of carbon dioxide formed changes with time when 4.0 g of calcium carbonate reacts with 50 cm<sup>3</sup> of 1.0 mol dm<sup>-3</sup> hydrochloric acid at 20 °C.

A second reaction was carried out under identical conditions with the same mass of calcium carbonate but using 50 cm<sup>3</sup> of 2.0 mol dm<sup>-3</sup> hydrochloric acid.

Which line (**A-F**) best represents how the volume of carbon dioxide formed changes with time in the second reaction?

( $M_r$  value:  $\text{CaCO}_3 = 100$ )

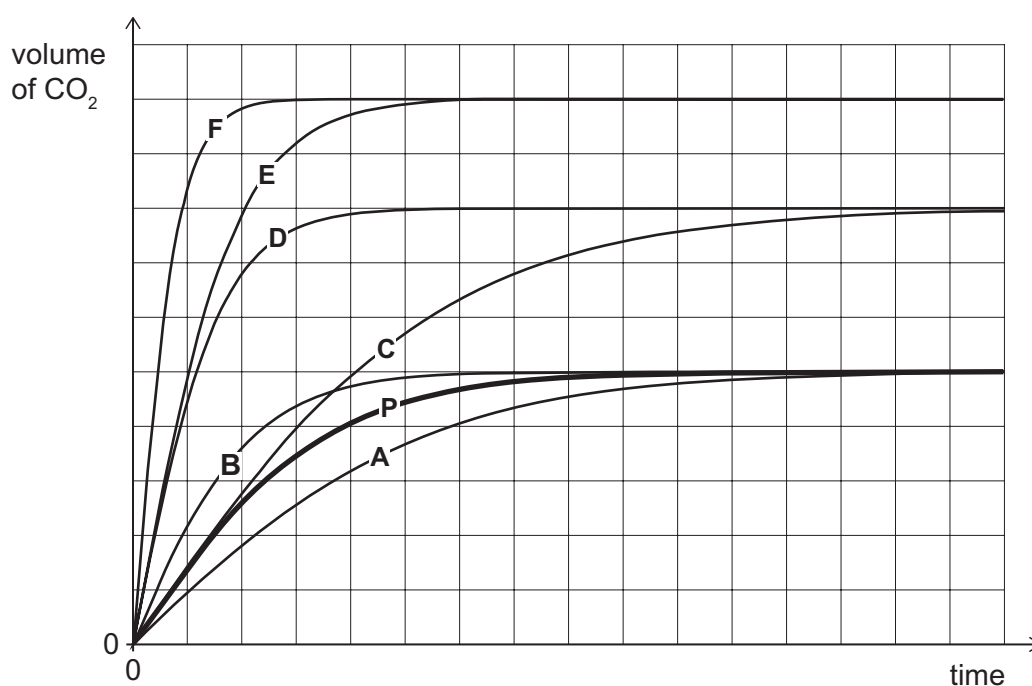

- 54** Hydrochloric acid, sulfuric acid and phosphoric(V) acid are inorganic acids.

Phosphoric(V) acid,  $\text{H}_3\text{PO}_4$ , ionises in water in the following series of reactions:

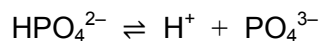
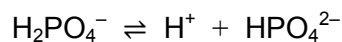
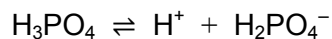

$0.1 \text{ mol dm}^{-3}$  hydrochloric acid has a pH of 1.0 at room temperature.

Which of the following statements about these acids is/are correct?

- 1** The pH of  $0.1 \text{ mol dm}^{-3}$  sulfuric acid is greater than 1.0 at room temperature.
  - 2**  $\text{H}_2\text{PO}_4^-$  can act as an acid or as a base.
  - 3**  $30 \text{ cm}^3$  of calcium hydroxide solution exactly neutralises  $20 \text{ cm}^3$  phosphoric(V) acid solution when both solutions are the same concentration.
- A** none of them
- B** 1 only
- C** 2 only
- D** 3 only
- E** 1 and 2 only
- F** 1 and 3 only
- G** 2 and 3 only
- H** 1, 2 and 3

- 55 Complete combustion of 1 mol of hydrocarbon X requires exactly 8.5 mol of oxygen.

Incomplete combustion of 1 mol of hydrocarbon X, to form carbon monoxide and water only, requires exactly 5.5 mol of oxygen.

How many hydrogen atoms are there in one molecule of hydrocarbon X?

- A 6
- B 8
- C 10
- D 12
- E 14

- 56 An element Z forms an ionic compound  $ZSO_4$  which has  $M_r = 120.4$

The ion of Z in  $ZSO_4$  has 10 electrons.

Element Z has three isotopes, labelled L, M and N, which contain the following numbers of neutrons.

<i>isotope</i>	L	M	N
<i>number of neutrons</i>	12	13	14

The percentage abundances of isotopes M and N are the same.

What is the percentage abundance of the isotope L in the element Z in  $ZSO_4$ ?

( $M_r$  value:  $SO_4^{2-} = 96.1$ )

- A 4.10%
- B 10.0%
- C 13.4%
- D 43.3%
- E 80.0%
- F 91.8%



- 57** An experiment is carried out using the first three metals in Group 1: lithium, sodium and potassium.

The initial masses of three open beakers each containing 100 g samples of an alcohol are recorded.

In three separate experiments, equal small masses of lithium, sodium and potassium are added to the three beakers, which are on electronic balances.

Each metal reacts in a similar way and after the reaction is complete, the final mass of each beaker and its contents is recorded.

In each case, the final mass of the beaker and its contents is compared to the recorded initial mass before the alkali metal was added.

Which of the following statements is correct?

- A** The beaker with lithium added would decrease in mass the most.
- B** The beaker with sodium added would decrease in mass the most.
- C** The beaker with potassium added would decrease in mass the most.
- D** All three beakers would show the same decrease in mass.
- E** The beaker with lithium added would increase in mass the most.
- F** The beaker with sodium added would increase in mass the most.
- G** The beaker with potassium added would increase in mass the most.
- H** All three beakers would show the same increase in mass.

- 58 Four separate experiments were carried out using different quantities of  $2 \text{ mol dm}^{-3}$  hydrochloric acid and  $2 \text{ mol dm}^{-3}$  sodium hydroxide in insulated polystyrene cups.

After stirring, the maximum temperature was recorded and the results plotted on a graph as shown.

The temperatures of the acid and alkali on their own were also plotted on the graph. Two straight lines were drawn and extrapolated as shown.

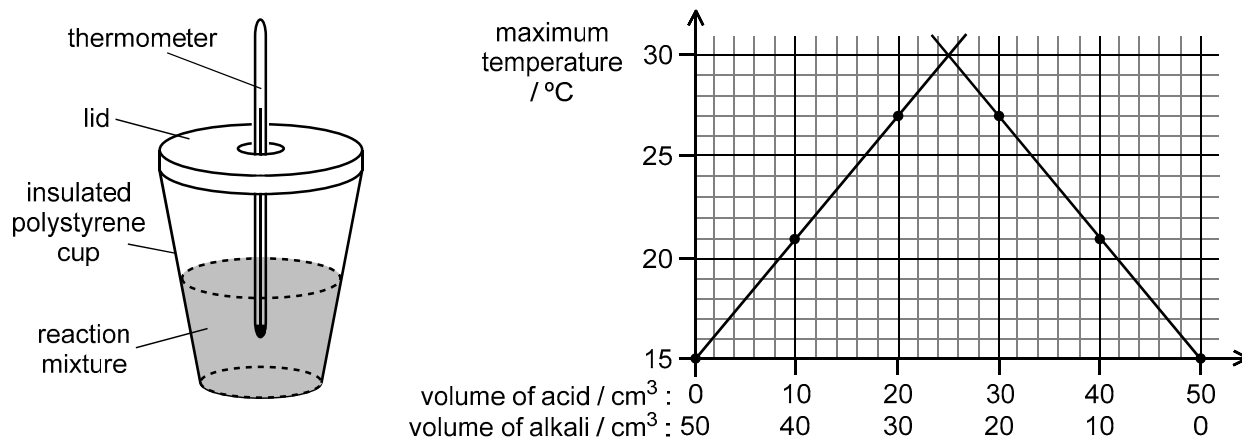

What is the molar enthalpy change for the neutralisation reaction, in  $\text{kJ mol}^{-1}$ ?

(Assume that the specific heat capacity of the solutions is  $4 \text{ J g}^{-1} \text{ }^{\circ}\text{C}^{-1}$ , the density of dilute solutions is  $1 \text{ g cm}^{-3}$ , and all heat is transferred to the solution.)

- A  $3 \text{ kJ mol}^{-1}$
- B  $6 \text{ kJ mol}^{-1}$
- C  $30 \text{ kJ mol}^{-1}$
- D  $60 \text{ kJ mol}^{-1}$
- E  $120 \text{ kJ mol}^{-1}$
- F  $3000 \text{ kJ mol}^{-1}$

- 59** An electric current is the flow of charged particles.

In an electrolysis of aluminium oxide using inert electrodes, the current flows at  $5.00 \times 10^{-6}$  moles of electrons per second.

Assume that only aluminium oxide is present and the aluminium is a single isotope  ${}_{13}^{27}\text{Al}$ .

What mass of aluminium is produced in 48 seconds?

- A** 0.04 mg
- B** 0.09 mg
- C** 0.52 mg
- D** 1.04 mg
- E** 1.08 mg
- F** 2.16 mg
- G** 3.12 mg
- H** 6.48 mg

- 60** X is a solution of sulfuric acid.

$20.0 \text{ cm}^3$  of X is diluted by adding distilled water to produce  $500 \text{ cm}^3$  of solution Y.

$10.0 \text{ cm}^3$  of Y is exactly neutralised by  $40.0 \text{ cm}^3$  of  $0.0500 \text{ mol dm}^{-3}$  aqueous potassium hydroxide.

What is the concentration of sulfuric acid in X?

- A**  $0.00100 \text{ mol dm}^{-3}$
- B**  $0.100 \text{ mol dm}^{-3}$
- C**  $0.200 \text{ mol dm}^{-3}$
- D**  $0.400 \text{ mol dm}^{-3}$
- E**  $1.25 \text{ mol dm}^{-3}$
- F**  $2.50 \text{ mol dm}^{-3}$
- G**  $5.00 \text{ mol dm}^{-3}$
- H**  $10.0 \text{ mol dm}^{-3}$

**BLANK PAGE**

**PART D Biology**

- 61** Which of the following **could** lead to phenotypic variation between a father and his son?
- 1** time spent in sunlight
  - 2** their genomes
  - 3** their diets
- A** none of them
- B** 1 only
- C** 2 only
- D** 3 only
- E** 1 and 2 only
- F** 1 and 3 only
- G** 2 and 3 only
- H** 1, 2 and 3
- 
- 62** Which of the following cells do not contain mitochondria?
- 1** bacterial cells
  - 2** embryonic stem cells
  - 3** mature red blood cells
  - 4** potato cells
- A** 1 only
- B** 2 only
- C** 3 only
- D** 4 only
- E** 1 and 2 only
- F** 1 and 3 only
- G** 1 and 4 only
- H** 2 and 4 only

- 63** A section of double-stranded DNA contains 4500 base pairs. 10% of the bases present are adenine.

Which of the following statements is/are correct?

- 1** There are 450 thymine bases present.
  - 2** 40% of the bases present are cytosine.
  - 3** There are 3600 guanine bases present.
- A** none of them
- B** 1 only
- C** 2 only
- D** 3 only
- E** 1 and 2 only
- F** 1 and 3 only
- G** 2 and 3 only
- H** 1, 2 and 3

64 The diagram shows part of the carbon cycle.

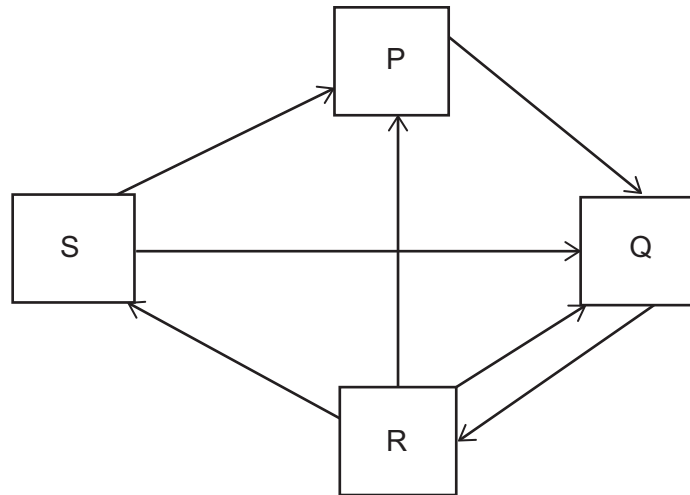

Which row identifies the correct descriptions for boxes P, Q, R and S?

	$CO_2$ in atmosphere	carbon-rich compounds in animals	carbon-rich compounds in decomposers	carbon-rich compounds in plants
<b>A</b>	P	Q	R	S
<b>B</b>	Q	P	S	R
<b>C</b>	S	Q	R	P
<b>D</b>	Q	S	P	R
<b>E</b>	S	R	Q	P
<b>F</b>	R	S	P	Q
<b>G</b>	P	R	Q	S
<b>H</b>	R	P	S	Q



**65** The diagram shows two human gametes, cell P and cell Q, fusing to form cell R.

Cell P carries an additional copy of one of its chromosomes so that it has one more chromosome than cell Q.

Cell R divides to form two cells S and T.

S and T grow into two separate individuals.

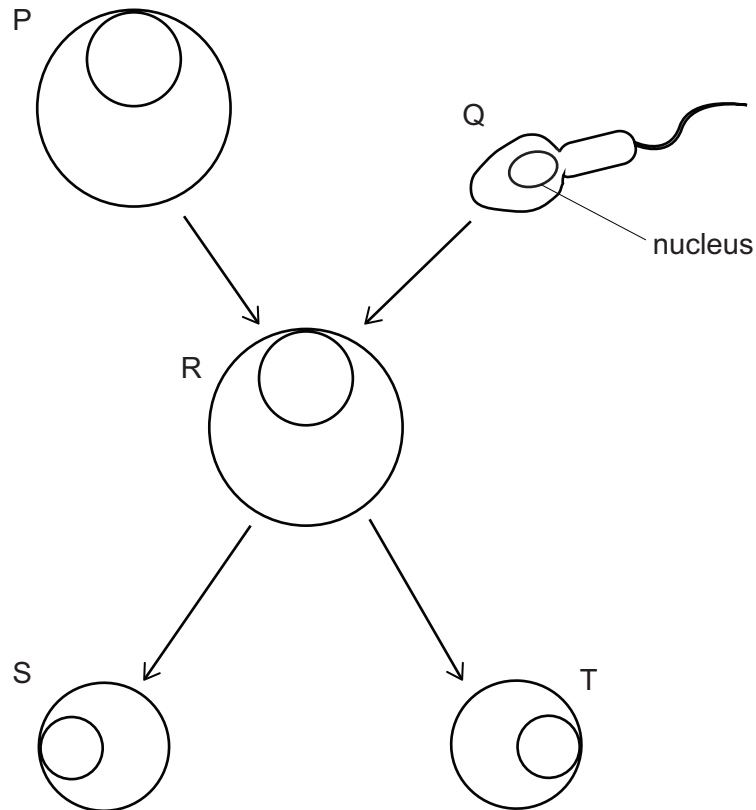

Using this information, which row shows the correct number of chromosomes in the nucleus of cell R and in the nucleus of cell T?

	<i>cell R</i>	<i>cell T</i>
<b>A</b>	23	24
<b>B</b>	24	47
<b>C</b>	24	48
<b>D</b>	46	46
<b>E</b>	47	24
<b>F</b>	47	47
<b>G</b>	92	47
<b>H</b>	93	93

**66** Pepsin and trypsin are both protease enzymes found in the human digestive system.

The graph shows how the activity of both enzymes varies with pH.

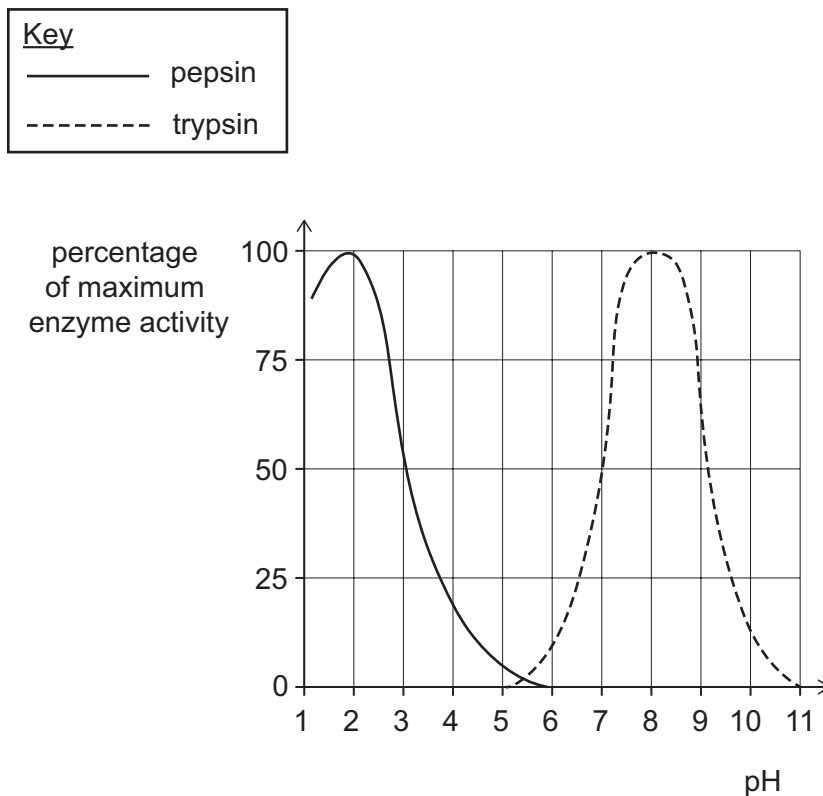

In the human digestive system:

- 1 pepsin is most active in the stomach.
- 2 trypsin would be inactive in the stomach.
- 3 pepsin could be a substrate for trypsin.
- 4 pepsin is most active at low acidity and trypsin most active at high acidity.

Which statements are correct?

- A 1 and 2 only
- B 1 and 3 only
- C 1 and 4 only
- D 2 and 3 only
- E 2 and 4 only
- F 3 and 4 only
- G 1, 2 and 3 only
- H 2, 3 and 4 only

- 67 The table shows concentrations of substances in blood entering and leaving three different organs of a person:

- kidney
- small intestine
- chambers of the right side of the heart

The blood sample was taken 10 minutes after the person had eaten a carbohydrate-rich meal.

organ	concentration in blood entering the organ			concentration in blood leaving the organ		
	glucose / mg dm <sup>-3</sup>	oxygen / arbitrary units	urea / mg dm <sup>-3</sup>	glucose / mg dm <sup>-3</sup>	oxygen / arbitrary units	urea / mg dm <sup>-3</sup>
1	9.0	65	3.0	9.0	65	3.0
2	9.0	85	3.0	9.0	70	2.4
3	9.0	85	3.0	12.0	70	3.0

Which row in the following table identifies the organs?

	organ 1	organ 2	organ 3
<b>A</b>	kidney	small intestine	chambers of the right side of the heart
<b>B</b>	kidney	chambers of the right side of the heart	small intestine
<b>C</b>	small intestine	kidney	chambers of the right side of the heart
<b>D</b>	small intestine	chambers of the right side of the heart	kidney
<b>E</b>	chambers of the right side of the heart	small intestine	kidney
<b>F</b>	chambers of the right side of the heart	kidney	small intestine

**68** SCID is an inherited condition in humans.

In one type of SCID, the white blood cells are unable to make the functional enzyme ADA, which is necessary for these cells to divide by mitosis during an immune response.

Scientists have developed a gene therapy treatment whereby a gene is inserted into the DNA of stem cells taken from the bone marrow of a person with this condition. These cells can then be returned to the body of the person, and can divide and differentiate into white blood cells. If this gene therapy is successful, the number of white blood cells should increase significantly.

Which of the following statements correctly describe(s) how this method of gene therapy might work to help a person with this type of SCID?

- 1** Genetically altered stem cells differentiate into white blood cells that are able to produce functional ADA.
  - 2** Genetically altered stem cells can differentiate into gametes so that offspring will not inherit SCID.
  - 3** The sequence of the bases in the DNA of the white blood cells, derived from the genetically altered stem cells, has changed.
- A** 1 only
- B** 2 only
- C** 3 only
- D** 1 and 2 only
- E** 1 and 3 only
- F** 2 and 3 only
- G** 1, 2 and 3

- 69** Which of the following could be a result of the addition of a large amount of organic material into a slow flowing river?
- 1** A decrease in biodiversity in the river.
  - 2** A reduction in the oxygen concentration gradient between the air and the water.
  - 3** An increase in the size of at least one aquatic population.
- A** none of them
- B** 1 only
- C** 2 only
- D** 3 only
- E** 1 and 2 only
- F** 1 and 3 only
- G** 2 and 3 only
- H** 1, 2 and 3

- 70** The table shows information about a human genetic condition called sickle cell anaemia and an infection called malaria. Both sickle cell anaemia and malaria can be fatal.

<i>genotype</i>	<i>phenotype</i>	<i>comment</i>
MM	does not show sickle cell anaemia	can be infected with malaria
Mm	does not show sickle cell anaemia	shows resistance to malaria
mm	shows sickle cell anaemia	shows more resistance to malaria than Mm

Which of the following statements is/are correct?

- 1** In areas without malaria, human populations are likely to have a low number of people with the m allele.
  - 2** In areas with malaria, only those individuals that are heterozygous will be able to pass on their alleles to the next generation.
  - 3** Presence of malaria has caused a mutation of the M allele to the m allele leading to an increased chance of survival in the heterozygous state.
- A** none of them
- B** 1 only
- C** 2 only
- D** 3 only
- E** 1 and 2 only
- F** 1 and 3 only
- G** 2 and 3 only
- H** 1, 2 and 3

71 The table shows the concentration of potassium ions in several different locations.

<i>location</i>	<i>concentration of potassium ions</i>
bacterial cell cytoplasm	$30 \text{ mmol dm}^{-3}$
mammalian blood plasma	$4000 \mu\text{mol dm}^{-3}$
mammalian heart cell cytoplasm	$1.0 \times 10^2 \text{ mmol dm}^{-3}$
sea water	$3.0 \times 10^4 \mu\text{mol dm}^{-3}$
yeast cell cytoplasm	$300 \text{ mmol dm}^{-3}$

Which of the following statements is/are correct?

- 1 A mammalian heart cell needs energy from respiration in order to obtain more potassium ions from blood plasma.
- 2 If a yeast cell is placed in sea water then it will lose potassium ions by osmosis.
- 3 There is no concentration gradient for potassium ions between a bacterial cell and sea water.

- A** none of them
- B** 1 only
- C** 2 only
- D** 3 only
- E** 1 and 2 only
- F** 1 and 3 only
- G** 2 and 3 only
- H** 1, 2 and 3

- 72 The graph shows the mass of product produced over time for an enzyme-controlled reaction in two different conditions, X and Y. All other variables were kept constant.

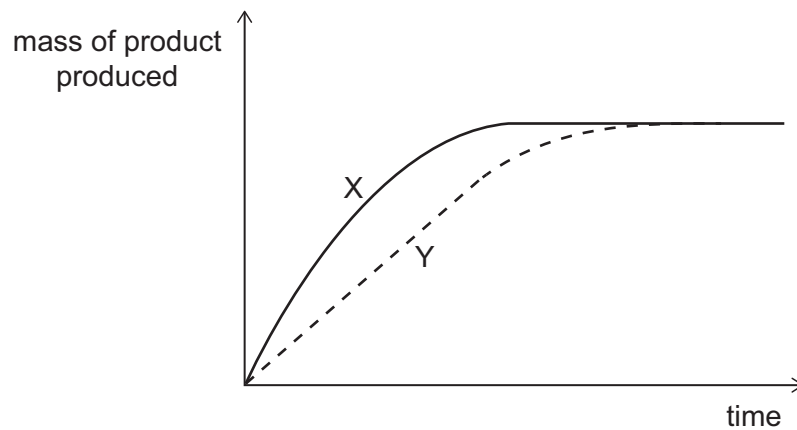

Which of the following could be correct for this graph?

- 1 Condition X is a higher pH than condition Y.
  - 2 Condition X has less substrate supplied than condition Y.
  - 3 Condition X is a lower pH than condition Y.
  - 4 Condition X has more substrate supplied than condition Y.
- A** none of them
- B** 1 and 2 only
- C** 1 and 3 only
- D** 1 and 4 only
- E** 2 and 3 only
- F** 2 and 4 only
- G** 3 and 4 only
- H** 1, 2, 3 and 4



- 73 A student investigated the endothermic reaction of photosynthesis in pondweed. The student set up the apparatus as shown in the diagram.

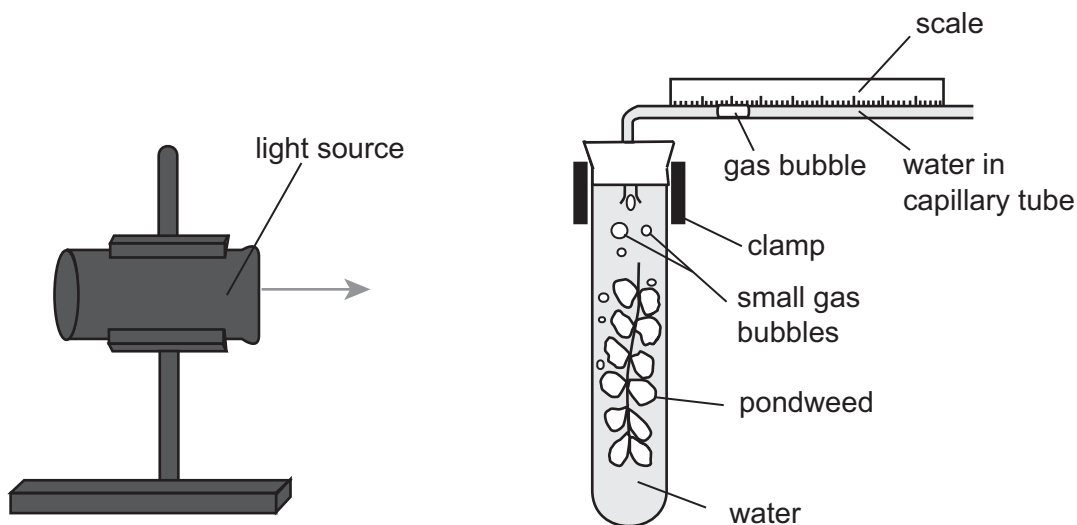

The experiment was left for 5 minutes and the distance moved by the gas bubble along a capillary tube of 2 mm diameter was recorded. Using these values, the rate of gas production is  $2\pi \text{ mm}^3$  per minute.

Which row of the table is correct?

	<i>total distance moved by the gas bubble during the experiment / mm</i>	<i>reason why the reaction is described as endothermic</i>	<i>observations if the light source was moved further from the pondweed</i>
<b>A</b>	0.5	the reaction releases energy	the gas bubble moves more slowly to the right
<b>B</b>	0.5	the reaction takes in energy	the gas bubble moves more slowly to the left
<b>C</b>	2.0	the reaction releases energy	the gas bubble moves more slowly to the left
<b>D</b>	2.0	the reaction releases energy	the gas bubble moves more slowly to the right
<b>E</b>	2.5	the reaction takes in energy	the gas bubble moves more slowly to the left
<b>F</b>	2.5	the reaction takes in energy	the gas bubble moves more slowly to the right
<b>G</b>	10.0	the reaction releases energy	the gas bubble moves more slowly to the left
<b>H</b>	10.0	the reaction takes in energy	the gas bubble moves more slowly to the right

**74** The abundance of a plant species in a habitat can be measured in different ways:

- the density (the number of that plant species per  $\text{m}^2$ )
- the frequency (the number of quadrats in which the plant species occurs)

The abundance of a plant species in a  $100 \text{ m}^2$  area of grassland was measured. The diagram below represents this area of grassland. Each black circle represents one individual of the plant species in this area of grassland.

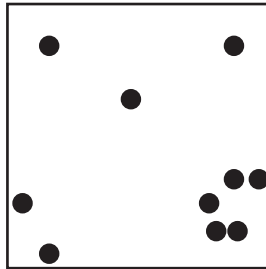

Two different size quadrats were used to sample the area:

- large quadrat ( $50 \text{ cm} \times 50 \text{ cm}$ )
- small quadrat ( $10 \text{ cm} \times 10 \text{ cm}$ )

The area is sampled randomly, first using 10 large quadrats and then a second time using 10 small quadrats.

Which of the following statements is/are correct?

- 1 The overall density in the grassland calculated from sampling with either size quadrat will always be the same.
- 2 The overall density in the grassland calculated from sampling will always be  $1 \text{ plant per m}^2$ .
- 3 The frequency obtained using the small quadrat will always be lower than that obtained with the large quadrat.

- A** none of them
- B** 1 only
- C** 2 only
- D** 3 only
- E** 1 and 2 only
- F** 2 and 3 only
- G** 1 and 3 only
- H** 1, 2 and 3

- 75 The diagram shows the changes in the volume of the ventricles, and the ECG trace that accompanies those changes, during two consecutive heart beats.

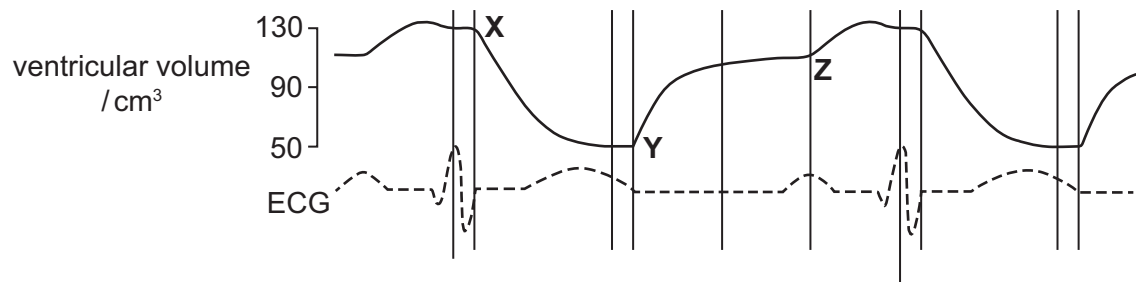

Which row is correct about the events happening at X, Y and Z?

	<i>at X blood is being pumped into</i>	<i>at Y valves between atria and ventricles are</i>	<i>chambers of the heart contracting at Z</i>
<b>A</b>	aorta	open	atria
<b>B</b>	aorta	closed	atria
<b>C</b>	atria	open	ventricles
<b>D</b>	atria	closed	ventricles
<b>E</b>	pulmonary artery	open	ventricles
<b>F</b>	pulmonary artery	closed	ventricles
<b>G</b>	pulmonary vein	open	atria
<b>H</b>	pulmonary vein	closed	atria

- 76** The placenta is an organ that develops during pregnancy. One function of the placenta is to allow the exchange of gases between the mother and the developing foetus.

The diagram represents the maternal and foetal blood flow between P and Q in a section of the placenta of a healthy small mammal. The concentration of oxygen in both maternal and foetal blood was measured at regular distances along this section.

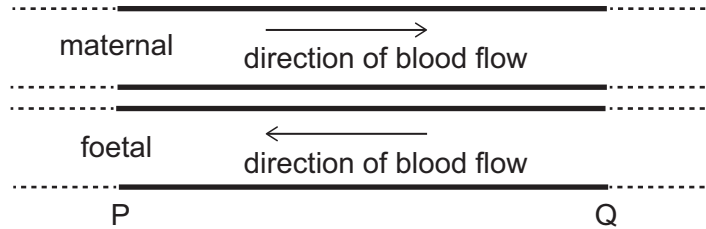

Which graph illustrates the concentration of oxygen in both maternal and foetal blood between P and Q?

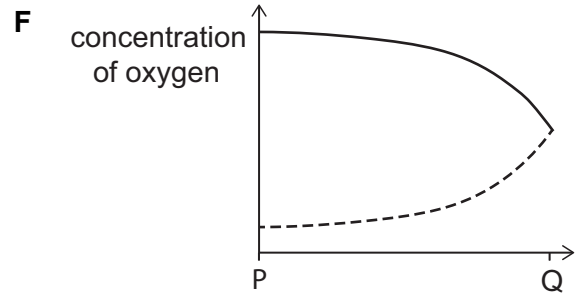
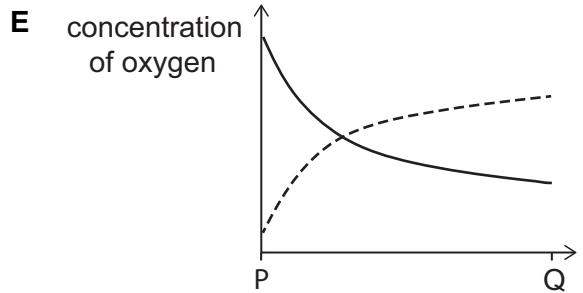
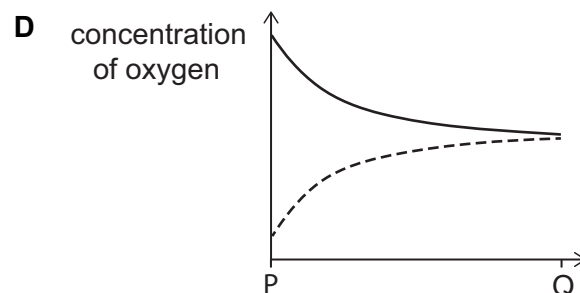
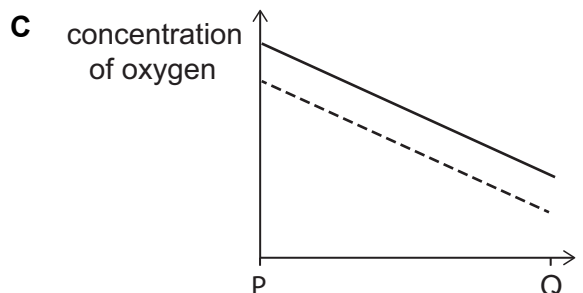
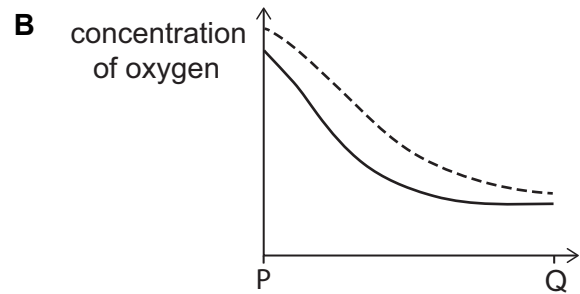
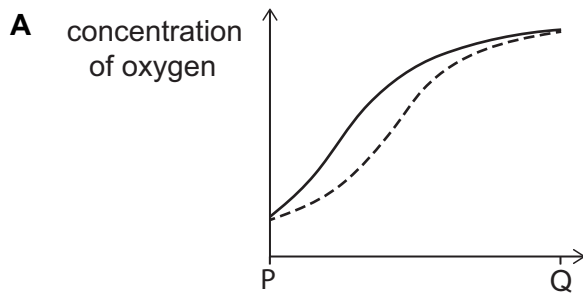
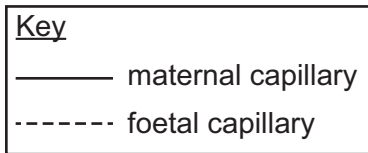

- 77 Catalase is an enzyme found inside plant and animal cells. When catalase is added to hydrogen peroxide, bubbles of oxygen gas are formed.

Red blood cells were placed into either water or plasma, and were placed in the dark.

Plant cells were placed into either water or  $0.5 \text{ mol dm}^{-3}$  sucrose solution, and were placed in the dark.

Assume that hydrogen peroxide and catalase do not cross the cell surface membrane.

Which row shows the results when hydrogen peroxide was added?

Key

✓ = oxygen bubbles will form

x = oxygen bubbles will not form

	<i>when hydrogen peroxide was added to</i>			
	<i>red blood cells in plasma</i>	<i>plant cells in a <math>0.5 \text{ mol dm}^{-3}</math> sucrose solution</i>	<i>red blood cells in water</i>	<i>plant cells in water</i>
<b>A</b>	✓	✓	x	x
<b>B</b>	x	x	✓	✓
<b>C</b>	x	x	✓	x
<b>D</b>	x	x	x	✓
<b>E</b>	✓	✓	✓	x
<b>F</b>	✓	✓	x	✓

- 78 Three different methods, X, Y and Z, of controlling pathogens in the human body are compared in the table.

<i>method of controlling the pathogen</i>	<i>affects bacterial pathogens</i>	<i>affects viral pathogens</i>	<i>requires the movement of human cells to have an effect</i>	<i>uses a molecule released from human cells</i>
X	yes	yes	yes	no
Y	yes	no	no	no
Z	yes	yes	no	yes

Which row in the following table is correct?

<i>method of controlling the pathogen</i>			
	X	Y	Z
<b>A</b>	may be stimulated by injections of inactivated pathogen	taking an antibiotic	may work by cells engulfing pathogens
<b>B</b>	may be stimulated by injections of inactivated pathogen	may work by cells engulfing pathogens	taking an antibiotic
<b>C</b>	taking an antibiotic	may be stimulated by injections of inactivated pathogen	may work by cells engulfing pathogens
<b>D</b>	taking an antibiotic	may work by cells engulfing pathogens	may be stimulated by injections of inactivated pathogen
<b>E</b>	may work by cells engulfing pathogens	may be stimulated by injections of inactivated pathogen	taking an antibiotic
<b>F</b>	may work by cells engulfing pathogens	taking an antibiotic	may be stimulated by injections of inactivated pathogen

**79** In rabbits, there are two alleles concerned with dark pigment in the fur:

- the dominant allele, B, for black colour
- the recessive allele, b, for brown colour

Two male black rabbits of unknown genotype each mated with a different female brown rabbit.

What is the expected proportion of brown offspring if both male rabbits are heterozygous, and what is the expected proportion of brown offspring if only one male rabbit is heterozygous?

	<i>expected proportion of brown offspring</i>	
	<i>if both male rabbits heterozygous</i>	<i>if only one male rabbit heterozygous</i>
<b>A</b>	0.25	0.5
<b>B</b>	0.25	1
<b>C</b>	0.5	0.25
<b>D</b>	0.5	1
<b>E</b>	1	0.25
<b>F</b>	1	0.5

- 80 The three family trees show the inheritance of three different genetic conditions, each controlled by one gene with one dominant and one recessive allele.

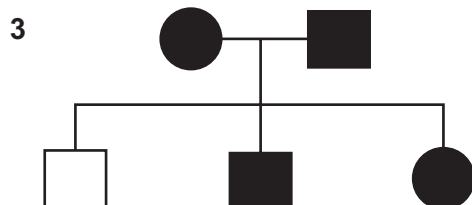
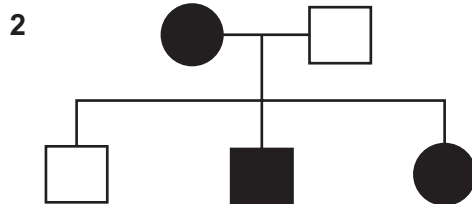
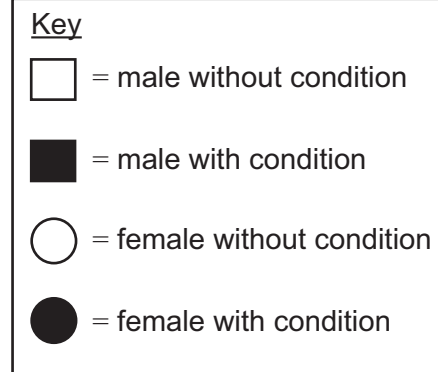
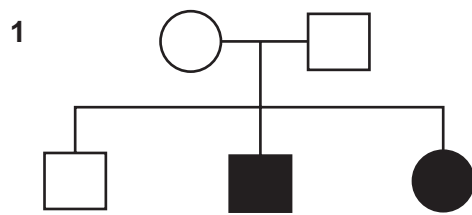

In which of the family trees **must** the male parent be heterozygous?

(Assume that no new mutations occur and that the genes are not found on the X chromosome.)

- A none of them
- B 1 only
- C 2 only
- D 3 only
- E 1 and 2 only
- F 1 and 3 only
- G 2 and 3 only
- H 1, 2 and 3



**BLANK PAGE**

**BLANK PAGE**

**BLANK PAGE**

